

# A Semi-Infinite Array of Parallel Metallic Plates of Finite Thickness for Microwave Systems\*

ROBIN I. PRIMICH†

**Summary**—An array of parallel metallic plates of finite thickness are useful in microwave lenses. The effect of finite thickness in the idealized situation of a semi-infinite array of perfect conductivity, is treated theoretically and experimentally for normal incidence of a uniform plane wave on the plane interface separating the medium from free space. The theoretical discussion involves the approximate variational method and a procedure is given for estimating the order of magnitude of the error in the final result. It is shown that it can be advantageous to use plates of finite thickness since the reflection from the interface can be reduced from that existing for infinitely thin plates.

## INTRODUCTION

TO OBTAIN a rigid structure, the practical use of a system of parallel metallic plates as a refracting medium in microwave systems, requires plates of appreciable thickness. The effect of this thickness on the reflecting and transmitting properties of the semi-infinite medium has caused much interest, but as yet no solution has been published, although Epstein<sup>1</sup> has given an empirical correction to the case of infinitely thin plates based on experimental evidence. An attempt was made by the author to extend the various rigorous theoretical methods to cover the case of plates of finite thickness, but these proved discouraging. Of the various approximate methods available, the variational method appears to be the most suitable as it provides a means of estimating the degree of approximation and also yields best results where the form of the trial field is known, as in the present case.

Using this method, formulas have been obtained for the complex reflection coefficients at the interface of a semi-infinite medium of parallel, perfectly conducting, metallic plates of finite thickness, for normal incidence of a uniform plane wave. An estimate of the order of accuracy is made by two methods. The polarization is such that electric vector is parallel to the plate edges. Theoretical results are confirmed by experimental results obtained in a strip transmission line at 8.0 to 11.0 cm wavelengths.

## THE VARIATIONAL METHOD

The variational technique, in its form due to Schwinger<sup>2</sup> has been used widely in microwave problems. For the present application it is convenient to obtain expres-

\* The work for this paper was performed at Imperial College, London, Eng.

† Def. Res. Board, Ottawa, Canada.

<sup>1</sup> D. J. Epstein, "Phase shift of microwaves in passage through parallel plate arrays," Tech. Rep. 42, Lab. for Insulation Res., M.I.T.; August, 1950.

<sup>2</sup> J. Schwinger, unpublished notes on waveguide discontinuities, foreword by Saxon.

sions for the complex impedance or admittance at the interface in terms of either the interface electric or magnetic field. These expressions are of such a form that they are stationary for arbitrary variations of the interface fields about their correct value. This means that if the assumed field distribution is in error to a certain order, then the desired impedance or admittance is in error to the second order, provided the original error is not too large.

The basic problem to be studied is that of the normal incidence of a uniform plane wave on the plane interface of a semi-infinite array of perfectly conducting, parallel, metallic plates of arbitrary thickness ( $b-a$ ) (Fig. 1). The spacing between the plates is occupied by

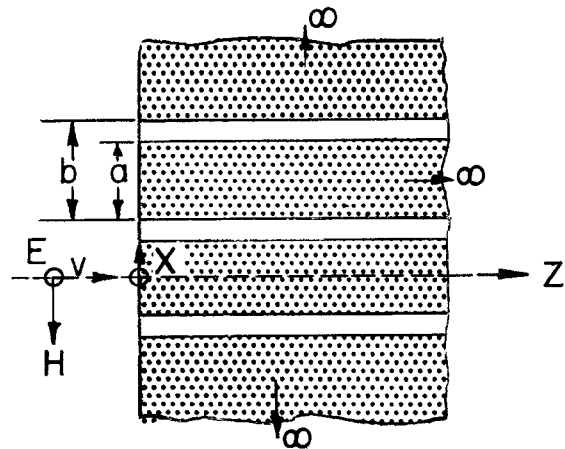

Fig. 1—A semi-infinite array of dielectric filled metal plates.

a dielectric of permittivity  $\epsilon$ . The spacing  $a$  is restricted to allow the propagation of the  $H_{01}$  mode only, *i.e.*,

$$a < \left( \lambda_{\epsilon} = \frac{\lambda_0}{\sqrt{\epsilon}} \right) < 2a$$

$\lambda_0$  = free space wavelength.

To obtain a particular variational expression it is necessary to evaluate either the tangential electric or magnetic fields at  $z=0$ , over some region  $b$ , and then to integrate over this region. Consequently, it is permissible to equate fields valid for all  $x$ , or fields valid in the region  $b$  only. The latter procedure results in considerable simplification and will be used.

The field equations have been developed by Berz<sup>3</sup> in a related problem and are directly applicable.

<sup>3</sup> F. Berz, "Reflection and refraction of microwaves at a set of parallel metallic plates," *Proc. IEE*, vol. 98, pt. 3, pp. 47-55; January, 1951.

For the polarization shown the problem is two-dimensional and the only three components of the field are:

$$E_y(x, z), H_x(x, z) = - (j/\omega\mu) \frac{\partial E_y}{\partial z}, \quad H_z(x, z) = (j/\omega\mu) \frac{\partial E_y}{\partial x}$$

and of these the continuity of  $E_y$  and  $H_x$  are only necessary to satisfy the boundary conditions at  $z=0$ . Furthermore, since there is no component perpendicular to the dielectric at  $z=0$ , it is sufficient to use  $\partial E_y/\partial x$  rather than  $H_x$ .

The fields are listed below.

Plate Region:  $z > 0$

$$\left. \begin{aligned} E_y &= \sum_{n=1}^{\infty} B_n \cos \frac{n\pi x}{a} \exp(-j\beta_n z) \\ \frac{\partial E_y}{\partial z} &= -j \sum_{n=1}^{\infty} \beta_n B_n \cos \frac{n\pi x}{a} \exp(-j\beta_n z) \end{aligned} \right\} \text{with } \beta_n^2 = \epsilon\beta_0^2 - \left(\frac{n\pi}{a}\right)^2 \quad |x| \leq \frac{a}{2}$$

and at  $z=0$

$$\left. \begin{aligned} E_{y_0} &= \sum_{n=1}^{\infty} B_n \cos \frac{n\pi x}{a} \\ \frac{\partial E_y}{\partial z} \Big|_0 &= -j \sum_{n=1}^{\infty} \beta_n B_n \cos \frac{n\pi x}{a} \end{aligned} \right\} \text{with } \beta_n^2 = \epsilon\beta_0^2 - \left(\frac{n\pi}{a}\right)^2 \quad |x| \leq \frac{a}{2}$$

by Fourier analysis

$$\begin{aligned} B_n &= \frac{2}{a} \int_{-a/2}^{a/2} E_{y_0} \cos \frac{n\pi x}{a} dx \\ &= \frac{2}{a} \int_{a_p} E_{y_0} \cos \frac{n\pi x}{a} dx \quad \int_{a_p} = \int_{-a/2}^{a/2} \end{aligned}$$

Free Space Region,  $z < 0$

Noting the periodicity  $b$  in the  $x$  direction, the field can be written as a Fourier Series valid for all  $x$  as follows:

$$\begin{aligned} E_y &= \exp(-j\beta_0 z) + A_0 \exp(j\beta_0 z) \\ &\quad + \sum_{m=1}^{\infty} A_m \cos \frac{2m\xi\pi x}{a} \exp(j\alpha_m z) \\ \frac{\partial E_y}{\partial z} &= -j\beta_0 \exp(-j\beta_0 z) + j\beta_0 A_0 \exp(j\beta_0 z) \\ &\quad + j \sum_{m=1}^{\infty} \alpha_m A_m \cos \frac{2m\xi\pi x}{a} \exp(j\alpha_m z) \\ \alpha_m &= \sqrt{\beta_0^2 - \left(\frac{2m\pi}{b}\right)^2}, \quad \beta_0 = \frac{2\pi}{\lambda_0}, \quad \xi = \frac{a}{b} \end{aligned}$$

and at  $z=0$

$$E_{y_0} = 1 + A_0 + \sum_{m=1}^{\infty} A_m \cos \frac{2m\xi\pi x}{a}$$

$$\frac{\partial E_y}{\partial z} \Big|_0 = -j(1 - A_0)\beta_0 + j \sum_{m=1}^{\infty} \alpha_m A_m \cos \frac{2m\xi\pi x}{a}$$

Then, by Fourier analysis,

$$1 + A_0 = \frac{1}{b} \int_{-b/2}^{b/2} E_{y_0} dx = \frac{1}{b} \int_{a_p} E_{y_0} dx$$

and

$$A_m = \frac{2}{b} \int_{a_p} E_{y_0} \cos \frac{2m\xi\pi x}{a} dx \quad \text{for } m \neq 0.$$

Equating the magnetic fields in the aperture

$$\left( H_{x_0} \text{ or } \frac{\partial E_y}{\partial z} \Big|_0 \right),$$

and substituting for  $A_m$  and  $B_n$ ;

$$\begin{aligned} -j \sum_{n=1}^{\infty} \beta_n \cos \frac{n\pi x}{a} \frac{2}{a} \int_{a_p} E_{y_0} \cos \frac{n\pi x}{a} dx \\ = -j(1 - A_0)\beta_0 + j \sum_{m=1}^{\infty} \alpha_m \cos \frac{2m\xi\pi x}{a} \\ \cdot \frac{2}{b} \int_{a_p} E_{y_0} \cos \frac{2m\xi\pi x}{a} dx. \end{aligned} \quad (1)$$

Multiplying by  $E_{y_0}$  and integrating over the aperture ( $|x| \leq a/2$ )

$$\begin{aligned} \beta_0(1 - A_0) \int_{a_p} E_{y_0} dx \\ = \frac{2}{a} \sum_{n=1}^{\infty} \beta_n \int_{a_p} E_{y_0} \cos \frac{n\pi x}{a} dx \int_{a_p} E_{y_0} \cos \frac{n\pi x}{a} dx \\ + \frac{2}{b} \sum_{m=1}^{\infty} \alpha_m \int_{a_p} E_{y_0} \cos \frac{2m\xi\pi x}{a} dx \int_{a_p} E_{y_0} \cos \frac{2m\xi\pi x}{a} dx \end{aligned}$$

and then dividing by

$$1 + A_0 = \frac{1}{b} \int_{ap} E_{y_0} dx$$

results in

$$\beta_0 \frac{1 - A_0}{1 + A_0} = \frac{2}{\xi} \sum_{n=1}^{\infty} \beta_n \left\{ \frac{\int_{ap} E_{y_0} \cos \frac{n\pi x}{a} dx}{\int_{ap} E_{y_0} dx} \right\}^2 + 2 \sum_{m=1}^{\infty} \alpha_m \left\{ \frac{\int_{ap} E_{y_0} \cos \frac{2m\xi\pi x}{a} dx}{\int_{ap} E_{y_0} dx} \right\}^2 \dots (2)$$

$$Y = \frac{1 - A_0}{1 + A_0}$$

has the dimensions of an admittance and is, in fact, the input admittance at the interface on the free space side. It is stationary with respect to arbitrary variations of  $E_{y_0}$  about its correct value. This can be seen from the following: taking the first variation of  $Y$  with respect to  $E_{y_0}$ ,

$$\delta \left[ \beta_0 Y \left\{ \int_{ap} E_{y_0} dx \right\}^2 \right] = \beta_0 \left\{ \int_{ap} E_{y_0} dx \right\}^2 \delta Y + \beta_0 Y 2 \int_{ap} E_{y_0} dx \int_{ap} \delta E_{y_0} dx = \frac{4}{\xi} \sum_{n=1}^{\infty} \beta_n \int_{ap} E_{y_0} \cos \frac{n\pi x}{a} dx \int_{ap} \delta E_{y_0} \cos \frac{n\pi x}{a} dx + 4 \sum_{m=1}^{\infty} \alpha_m \int_{ap} E_{y_0} \cos \frac{2m\xi\pi x}{a} dx \int_{ap} \delta E_{y_0} \cos \frac{2m\xi\pi x}{a} dx.$$

Assuming that the order of summation and integration can be interchanged,

$$\beta_0 \left\{ \int_{ap} E_{y_0} dx \right\}^2 \delta Y = 2 \int_{ap} \delta E_{y_0} \left[ \frac{2}{\xi} \sum_{n=1}^{\infty} \beta_n \cos \frac{n\pi x}{a} \int_{ap} E_{y_0} \cos \frac{n\pi x}{a} dx + 2 \sum_{m=1}^{\infty} \alpha_m \cos \frac{2m\xi\pi x}{a} \int_{ap} E_{y_0} \cos \frac{2m\xi\pi x}{a} dx - \beta_0 \frac{1 - A_0}{1 + A_0} \int_{ap} E_{y_0} dx \right].$$

Using

$$1 + A_0 = \frac{1}{b} \int_{ap} E_{y_0} dx,$$

the expression in square brackets is zero by virtue of (1). Therefore  $\delta Y = 0$ , and  $Y$  is stationary.

Eq. (2) yields  $A_0$ , the complex reflection coefficient at the interface for free space incidence, and partially specifies the properties of the interface. To complete this specification<sup>4</sup> it is necessary to find  $B$  the complex reflection coefficient for plate region incidence; *i.e.*, the fields now are,

$$E_y = \cos \frac{\pi x}{a} \exp \cdot (j\beta_1 z) + B_1 \cos \frac{\pi x}{a} \exp \cdot (-j\beta_1 z) + \sum_{n=3}^{\infty} B_n \cos \frac{n\pi x}{a} \exp \cdot (-j\beta_n z) \quad |x| \leq \frac{a}{2}, z < 0$$

$$E_y = A_0 \exp \cdot (j\beta_0 z) + \sum_{n=1}^{\infty} A_n \cos \frac{2m\xi\pi x}{a} \exp \cdot (j\alpha_n z) \quad z < 0.$$

Note that  $B_n$  and  $A_m$  do not have the same values as for free space incidence, but the same symbols have been used to distinguish the plate region and free space region fields respectively.

In exactly the same way as before, one obtains, by equating the magnetic fields in the plane  $z=0$ ,

$$\beta_0 \frac{1 - \beta_1}{1 + B_1} = \frac{\beta_0 \xi}{2} \left\{ \frac{\int_{ap} E_{y_0} dx}{\int_{ap} E_{y_0} \cos \frac{\pi x}{a} dx} \right\}^2 + \sum_{n=3}^{\infty} \beta_n \left\{ \frac{\int_{ap} E_{y_0} \cos \frac{n\pi x}{a} dx}{\int_{ap} E_{y_0} \cos \frac{\pi x}{a} dx} \right\}^2 + \xi \sum_{m=1}^{\infty} \alpha_m \left\{ \frac{\int_{ap} E_{y_0} \cos \frac{2m\xi\pi x}{a} dx}{\int_{ap} E_{y_0} \cos \frac{\pi x}{a} dx} \right\}^2 \dots (3)$$

$$Y = \frac{1 - B_1}{1 + B_1}$$

is now the input admittance at the interface for plate region incidence and it can be shown to be stationary.

<sup>4</sup> R. I. Primich, "A general experimental method to determine the properties of an artificial delay medium, applied to semi-infinite array of parallel metallic plates," *Proc. IEE*, vol. 102, pt. B, pp. 26-36; January, 1955.

In the absence of loss,  $|B_1|_p = |A_0|_0$  since  $B_{1p}$  is now the complex reflection coefficient on the plate region side.

There are two corresponding expressions for

$$\frac{1 + A_0}{1 + A_0} \quad \text{and} \quad \frac{1 + B_1}{1 - B_1}$$

in terms of the tangential magnetic field in the aperture plane. The derivation is similar to the above except that the electric fields are now equated in the aperture, piecewise over the regions

$$|x| \leq \frac{a}{2} \quad \text{and} \quad |x| \leq \frac{b-a}{2}.$$

The results are

$$\frac{1}{\beta_0} \frac{1 + A_0}{1 - A_0} = \frac{2}{\xi} \sum_{n=1}^{\infty} \frac{1}{\beta_n} \left\{ \frac{\int_{a_p} F_0 \cos \frac{n\pi x}{a} dx}{\int_b F_0 dx} \right\}^2 + 2 \sum_{m=1}^{\infty} \frac{1}{\alpha_m} \left\{ \frac{\int_b F_0 \cos \frac{2m\xi\pi x}{a} dx}{\int_b F_0 dx} \right\}^2 \dots \quad (4)$$

and

$$\frac{1}{\beta_1} \frac{1 + B_1}{1 - B_1} = \frac{\xi}{2\beta_0} \left\{ \frac{\int_b F_0 dx}{\int_{a_p} F_0 \cos \frac{\pi x}{a} dx} \right\}^2 + \sum_{n=3}^{\infty} \frac{1}{\beta_n} \left\{ \frac{\int_{a_p} F_0 \cos \frac{n\pi x}{a} dx}{\int_{a_p} F_0 \cos \frac{\pi x}{a} dx} \right\}^2 + \xi \sum_{m=1}^{\infty} \frac{1}{\alpha_m} \left\{ \frac{\int_b F_0 \cos \frac{2m\xi\pi x}{a} dx}{\int_b F_0 \cos \frac{\pi x}{a} dx} \right\}^2 \dots \quad (5)$$

where

$$F_0 = \left. \frac{\partial E_y}{\partial z} \right|_0 \propto H_{x_0}$$

$$\frac{1 + A_0}{1 - A_0} \quad \text{and} \quad \frac{1 + B_1}{1 - B_1}$$

now have the dimensions of an impedance  $Z$  and, in fact, are the complex input impedances at the interface for free space and plate region incidence respectively.

They are stationary with respect to arbitrary variations of  $E_{y_0}$  about the correct value.

#### AN ESTIMATE OF THE ERROR IN THE VARIATIONAL SOLUTION

##### Use of the Complex Plane

For a given region of incidence there are a pair of corresponding expressions giving the input impedance at the interface in terms of the electric or magnetic fields in the aperture plane; *i.e.*,

$$Z_E = \left[ \frac{1 - A_0}{1 - A_0} \right]_E \quad \text{from (2)}$$

$$Z_H = \left[ \frac{1 + A_0}{1 - A_0} \right] \quad \text{from (4)}.$$

Now for the correct fields  $E_{y_0}$  and  $F_0$ ,  $Z_E = Z_H$ , but for any approximate field  $Z_E \neq Z_H$ . However, if it is assumed that it is possible to express  $E_{y_0}$  as a sum of terms which successively represent better approximations, then if  $Z_E = R_E + jX_E$  is plotted in the complex plane for various degrees of approximation, a curve results which must eventually approach the correct value of  $Z_E$ , and a similar curve for  $Z_H = R_H + jX_H$  must eventually intersect it at  $Z_E = Z_H$ . Practically, it is possible to predict the point of intersection  $Z_E = Z_H$  by using a reasonable number of approximations. In the present instance, the aperture fields can be written as a series of known forms in which the addition of a single term represents a better approximation to the correct field.

An alternative approach to this problem has been used by Miles<sup>5</sup> who, in a study of an array of parallel metallic strips, showed that  $R_E$ ,  $R_H$  and  $X_E$ ,  $X_H$  are individually stationary and bounded. This means that  $A_0$  and  $B_{1p}$  are known within wider limits than  $R_E$  and  $X_E$  or  $R_H$  and  $X_H$  and in general these limits are wider than given by the above method.

##### Equivalent Circuit Method

An alternative method of estimating the error is based on a suggestion of Brown's<sup>6</sup> and is very similar to that used by Collin,<sup>7</sup> but it is derived in terms of different parameters.

By using a short circuit termination in either the free space or plate regions, the input impedances and admittances become purely imaginary and one may associate with them a three-element reactive network, the values of which can be found from three short circuit positions.

<sup>5</sup> J. W. Miles, "On the diffraction of an electromagnetic wave through a plane screen," *J. Appl. Phys.*, vol. 20, pp. 760-771; August, 1949.

<sup>6</sup> J. Brown, letter in *Electronic Engrg.*; October, 1950.

<sup>7</sup> R. E. Collin, "Interface problems at dielectric discontinuities in waveguides," Ph.D. dissertation, Univ. of London, Eng.; 1953.

A typical variational expression will be derived, *i.e.*, for free space incidence, and in terms of the aperture electric field. (See Fig. 2.)

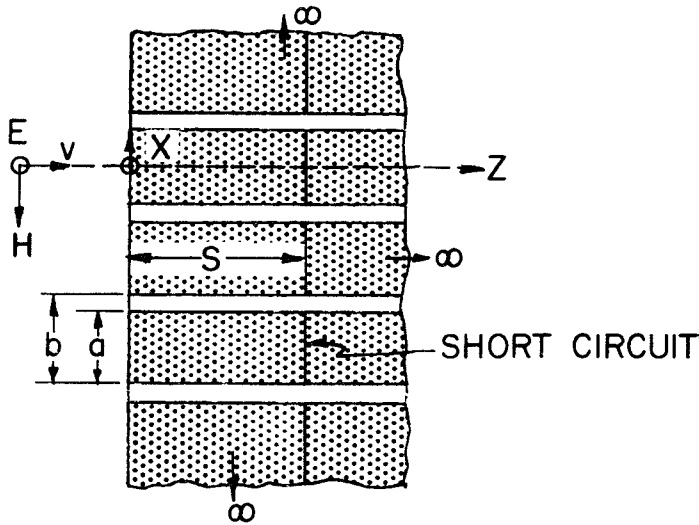

Fig. 2—A semi-infinite array of metal plates with short circuit termination.

The distance  $S$  is such that the evanescent modes excited at the interface are of negligible amplitude at the short circuit. At some plane  $Z$  in free space, again sufficiently far from the interface, the electric field will have a zero value. Let the distance of this plane from the interface be  $d$ .

If  $B_1 \cos \pi x/a \exp(-j\beta_1 z)$  is the transmitted wave in the plate region, there will be a reflected wave  $\exp(j\phi_p) B_1 \cos \pi x/a \exp j\beta_1 z$  due to the short circuit, where  $\phi_p$  is the wave's phase referred to  $Z=0$ . At  $Z=S$  the total electric field must be zero, which gives  $\phi_p = \pi - 2\beta_1 S$ .

The total plate region field is then

$$\left. \begin{aligned} E_y &= 2B_1 \cos \frac{\pi x}{a} \exp\left(j\frac{\phi_p}{2}\right) \cos\left(\beta_1 z + \frac{\phi_p}{2}\right) + \sum_{n=3}^{\infty} B_n \cos \frac{n\pi x}{a} \exp(-j\beta_n z) \\ \frac{\partial E_y}{\partial z} &= -2\beta_1 B_1 \cos \frac{\pi x}{a} \exp\left(j\frac{\phi_p}{2}\right) \sin\left(\beta_1 z + \frac{\phi_p}{2}\right) - j \sum_{n=3}^{\infty} \beta_n B_n \cos \frac{n\pi x}{a} \exp(-j\beta_n z) \end{aligned} \right\} |x| \leq \frac{a}{2}$$

at  $Z=0$ ,

$$E_{y0} = 2B_1 \cos \frac{\pi x}{a} \exp j\frac{\phi_p}{2} \cos \frac{\phi_p}{2} + \sum_{n=3}^{\infty} B_n \cos \frac{n\pi x}{a}$$

$$\left. \frac{\partial E_y}{\partial z} \right|_0 = -2\beta_1 B_1 \cos \frac{\pi x}{a} \exp\left(j\frac{\phi_p}{2}\right)$$

$$\cdot \sin \frac{\phi_p}{2} - j \sum_{n=3}^{\infty} \beta_n B_n \cos \frac{n\pi x}{a}$$

by Fourier analysis,

$$2B_1 \exp\left(j\frac{\phi_p}{2}\right) \cos \frac{\phi_p}{2} = \frac{2}{a} \int_{ap} E_{y0} \cos \frac{\pi x}{a} dx$$

$$B_n = \frac{2}{a} \int_{ap} E_{y0} \cos \frac{n\pi x}{a} dx.$$

The free space magnetic field is still given by

$$\left. \frac{\partial E_y}{\partial z} \right|_0 = -j\beta_0(1 - A_0)$$

$$+ j \frac{2}{b} \sum_{m=1}^{\infty} \alpha_m \cos \frac{2m\xi\pi x}{a} \int_{ap} E_{y0} \cos \frac{2m\xi\pi x}{a} dx.$$

Equating these in the aperture ( $|x| \leq a/2$ ) and multiplying by  $E_{y0}$ , then integrating over  $|x| \leq a/2$  and dividing by

$$1 + A_0 = \frac{1}{b} \int_{ap} E_y dy,$$

there results, finally

$$j\beta_0 \frac{1 - A_0}{1 + A_0} = -\frac{2\beta_1}{\xi} \tan \frac{\phi_p}{2} \left\{ \frac{\int_{ap} E_{y0} \cos \frac{\pi x}{a} dx}{\int_{pa} E_{y0} dx} \right\}^2$$

$$+ j \frac{2}{\xi} \sum_{n=3}^{\infty} \beta_n \left\{ \frac{\int_{ap} E_{y0} \cos \frac{n\pi x}{a} dx}{\int_{ap} E_{y0} dx} \right\}^2$$

$$+ j2 \sum_{m=1}^{\infty} \alpha_m \left\{ \frac{\int_{ap} E_{y0} \cos \frac{2m\xi\pi x}{a} dx}{\int_{ap} E_{y0} dx} \right\}^2$$

put

$$\frac{\alpha_m}{\beta_0} = -jQ_m; \quad \frac{\beta_n}{\beta_0} = -jR_n$$

and

$$\frac{\beta_1}{\beta_0} = N;$$

$Q_m, R_n$  are real and positive for  $m, n \neq 1$ . Under short circuit conditions  $A_0 = \exp(j\phi_0)$ ,  $\phi_0 =$  phase of the unit reflected wave referred to  $z=0$ . Then

$$\frac{1 - A_0}{1 + A_0} = -j \tan \frac{\phi_0}{2}$$

and so

$$\tan \frac{\phi_0}{2} = \frac{2N}{\xi} \tan \frac{\phi_p}{2} \left\{ \frac{\int_{ap} E_{y_0} \cos \frac{\pi x}{a} dx}{\int_{ap} E_{y_0} dx} \right\}^2 + \frac{2}{\xi} \sum_{n=3}^{\infty} R_n \left\{ \frac{\int_{ap} E_{y_0} \cos \frac{n\pi x}{a} dx}{\int_{ap} E_{y_0} dx} \right\}^2 + 2 \sum_{m=1}^{\infty} Q_m \left\{ \frac{\int_{ap} E_{y_0} \cos \frac{2m\xi\pi x}{a} dx}{\int_{ap} E_{y_0} dx} \right\}^2 \dots \quad (6)$$

The corresponding magnetic field expression is

$$\cot \frac{\phi_0}{2} = \frac{2}{\xi N} \cot \frac{\phi_p}{2} \left\{ \frac{\int_{ap} H_{x_0} \cos \frac{\pi x}{a} dx}{\int_{ap} H_{x_0} dx} \right\}^2 + \frac{2}{\xi} \sum_{n=3}^{\infty} \frac{1}{R_n} \left\{ \frac{\int_{ap} H_{x_0} \cos \frac{n\pi x}{a} dx}{\int_{ap} H_{x_0} dx} \right\}^2 + 2 \sum_{m=1}^{\infty} \frac{1}{Q_m} \left\{ \frac{\int_b H_{x_0} \cos \frac{2m\xi\pi x}{a} dx}{\int_{ap} H_{x_0} dx} \right\}^2 \quad (7)$$

Both expressions are stationary and, for arbitrary variations about  $E_{y_0}(H_{x_0})$ ,  $\tan \phi_0/2(\cot \phi_0/2)$  is an absolute minimum (since  $\tan \phi_0/2(\cot \phi_0/2)$  is real). Consequently for any trial field  $\tan \phi_0/2(E_{y_0})$  is too large and  $\tan \phi_0/2(H_{x_0})$  is too small. Thus for any three values of  $\tan \phi_p/2$  (short circuit position) three reactances can be determined within known limits. However, only two of these reactances can be identified with known terminations in the equivalent circuit, but by setting up two similar variational expressions for plate region incidence, a further two reactances may be found and any three of the four may be chosen.

The expressions for plate region incidence are

$$N \tan \frac{\phi_p}{2} = -\frac{\xi}{2} \tan \frac{\phi_0}{2} \left\{ \frac{\int_{ap} E_{y_0} dx}{\int_{ap} E_{y_0} \cos \frac{\pi x}{a} dx} \right\}^2 + \sum_{n=3}^{\infty} R_n \left\{ \frac{\int_{ap} E_{y_0} \cos \frac{n\pi x}{a} dx}{\int_{ap} E_{y_0} \cos \frac{\pi x}{a} dx} \right\}^2 + \xi \sum_{m=1}^{\infty} Q_m \left\{ \frac{\int_{ap} E_{y_0} \cos \frac{2m\xi\pi x}{a} dx}{\int_{ap} E_{y_0} \cos \frac{\pi x}{a} dx} \right\}^2 \quad (8)$$

$$\frac{1}{N} \cot \frac{\phi_p}{2} = -\frac{\xi}{2} \cot \frac{\phi_0}{2} \left\{ \frac{\int_b H_{x_0} dx}{\int_{ap} H_{x_0} \cos \frac{\pi x}{a} dx} \right\}^2 + \sum_{n=3}^{\infty} \frac{1}{R_n} \left\{ \frac{\int_{ap} H_{x_0} \cos \frac{n\pi x}{a} dx}{\int_{ap} H_{x_0} \cos \frac{\pi x}{a} dx} \right\}^2 + \xi \sum_{m=1}^{\infty} \frac{1}{Q_m} \left\{ \frac{\int_b H_{x_0} \cos \frac{2m\xi\pi x}{a} dx}{\int_{ap} H_{x_0} \cos \frac{\pi x}{a} dx} \right\}^2 \quad (9)$$

#### DETERMINATION OF THE REACTANCES

Fig. 3 shows the form of the assumed equivalent circuit. All impedances are purely reactive and are normalized relative to  $Z_0$ .

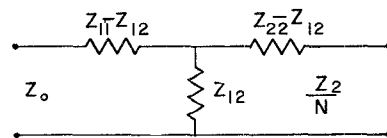

Fig. 3—Equivalent circuit of interface.

Two simple equivalent circuit terminations that can be associated with the short circuit positions in the thick plate system are the open and short circuit conditions.

#### FREE SPACE INCIDENCE

For any termination  $Z_R$ , the input impedance (Fig. 3) is

$$Z_{in} = Z_{11} - \frac{Z_{12}^2}{Z_{22} + Z_R}$$

1) Short circuit termination, ( $Z_R = 0$ )

$$Z_{in} = \frac{Z_{11}Z_{22} - Z_{12}^2}{Z_{22}}$$

$$= j \frac{X_{11}X_{22} - X_{12}^2}{X_{22}} \text{ for } Z_{11} = jX_{11}, Z_{22} = jX_{22}, Z_{12} = jX_{12}.$$

2) Open circuit termination, ( $Z_R = \infty$ )

$$Z_{in} = Z_{11} = jX_{11}.$$

Now in the plate system  $\tan \phi_p/2$  is the susceptance produced at  $z = +0$  by the short circuit at some position  $s$ . Thus,

$$Z_R = 0 \text{ corresponds to } \tan \frac{\phi_p}{2} = \infty$$

$$Z_R = \infty \text{ corresponds to } \tan \frac{\phi_p}{2} = 0.$$

Therefore

$$\frac{1}{X_{11}} = \tan \frac{\phi_0}{2} = (6) \text{ for } \tan \frac{\phi_p}{2} = 0$$

$$\frac{X_{22}}{X_{11}X_{22} - X_{12}^2} = \tan \frac{\phi_0}{2} = (6) \text{ for } \tan \frac{\phi_p}{2} = \infty.$$

Similarly, for plate region incidence,

$$\frac{1}{X_{22}} = \tan \frac{\phi_p}{2} = (8) \text{ for } \tan \frac{\phi_0}{2} = 0$$

$$\frac{X_{11}}{X_{11}X_{22} - X_{12}^2} = \tan \frac{\phi_p}{2} = (8) \text{ for } \tan \frac{\phi_0}{2} = \infty.$$

Hence,

$$X_{11}, X_{22}, \frac{X_{11}X_{22} - X_{12}^2}{X_{22}}, \frac{X_{11}X_{22} - X_{12}^2}{X_{11}}$$

so determined will be too small, while, from the corresponding magnetic field expressions, they will be too large and thus the reactances are known within limits. Therefore, it is only necessary to find  $X_{11}$ ,  $X_{22}$  together with either

$$\frac{X_{11}X_{22} - X_{12}^2}{X_{22}} \text{ or } \frac{X_{11}X_{22} - X_{12}^2}{X_{11}}.$$

#### NUMERICAL WORK

##### Choice of a Trial Field

One of the most important factors in determining the final accuracy in the variational method is the choice of the type of trial field. For the aperture electric field in the plate region the field expansion is known, *i.e.*,

$$E_{y0} = \sum_{n=1}^{\infty} B_n \cos \frac{n\pi x}{a} \quad |x| \leq a/2.$$

Using this in (2) and (3) the formulas for numerical computation (listed in the appendix) are obtained.

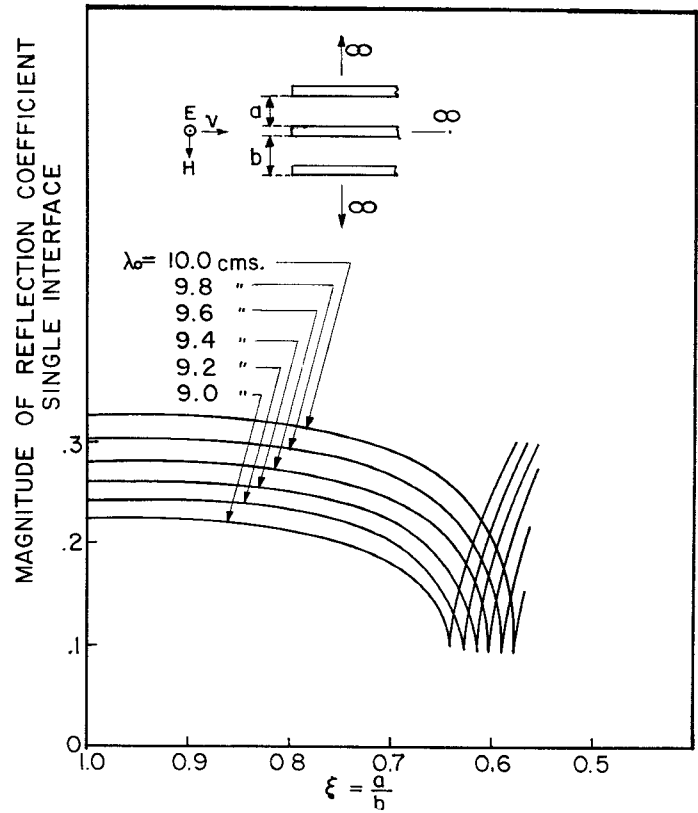

Fig. 4—Phase of reflection coefficient for single interface.

A logical choice of magnetic field is given by an expansion of the type given above for  $|x| \leq (a/2)$ , and an expansion representing the current distribution over the plate edges. Apart from involving two sets of unknown coefficients, the form of the current distribution is not known, so it is far more convenient to use a more general expansion of the type already encountered for the free space region, *i.e.*,

$$H_{x0} = 1 + \sum_{m=1}^{\infty} C_m \exp \left( \cos \frac{2m\pi x}{b} \right) \quad |x| \leq b/2.$$

The formulas obtained by using this in (4) and (5) are listed in the Appendix.

A maximum of four terms is used in each expansion and these are referred to as fourth approximations.

##### Calculations for a Typical System

The system chosen has  $2a = 11.56$  cm, with no dielectric filling and a wavelength range 9.0 to 10.0 cm, or a refractive index variation of 0.5 to 0.6.

Figs. 4–6 illustrate the magnitude and phase of the complex reflection coefficients for a single interface as a function of the parameter  $\xi = a/b$ . The curves are thus for a fixed wavelength, constant  $a$  (and thus a constant refractive index), for increasing plate thickness.

To obtain some idea of the dispersive properties of such a system, Fig. 7 illustrates the same information as a function of wavelength for various values of  $\xi$ .

The calculations were carried out using the electric

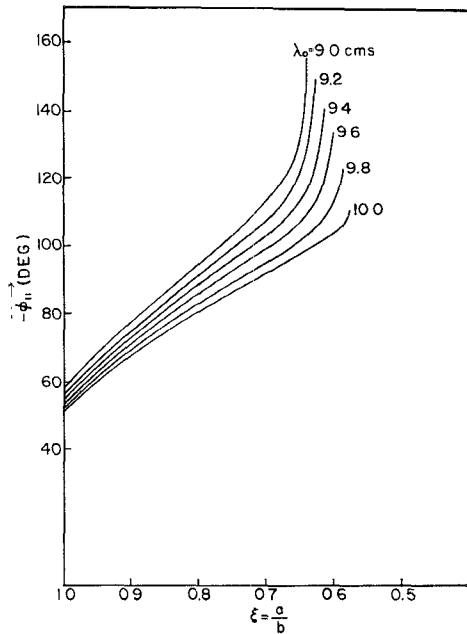

Fig. 5—Phase of reflection coefficient for single interface on free space side.

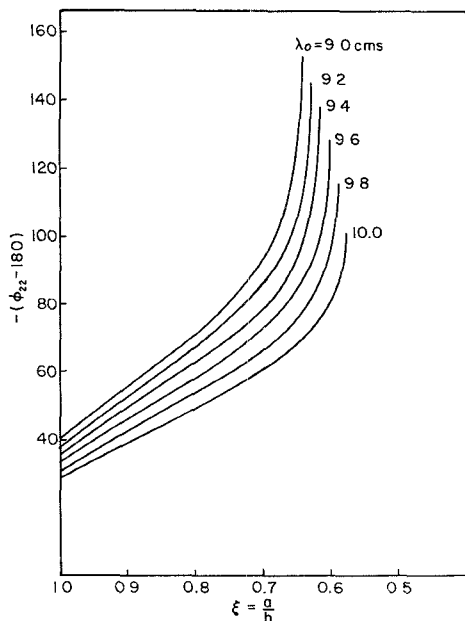

Fig. 6—Phase of reflection coefficient for plate region side.

field expressions with only the second approximation. An estimate of the error (see following section) shows that at  $\xi = 1.0$ ,  $\lambda_0 = 9$  cm, the magnitude of the reflection coefficient is 3 per cent too low and the phase is within 5 per cent.

The resonance occurs at  $\lambda_0 = b$ , and for  $\lambda_0 < b$  higher order freely propagating modes are present in free space. Although the calculations are still valid in this region, they are incomplete to the extent that they do not include the amplitudes of these higher order waves.

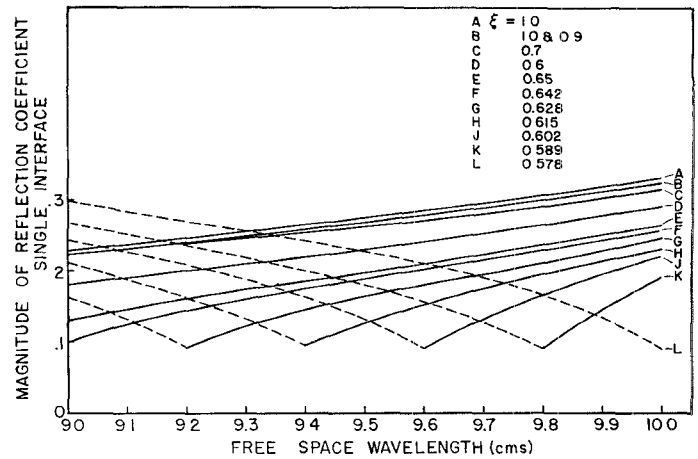

Fig. 7—Magnitude of reflection coefficient for single interface.

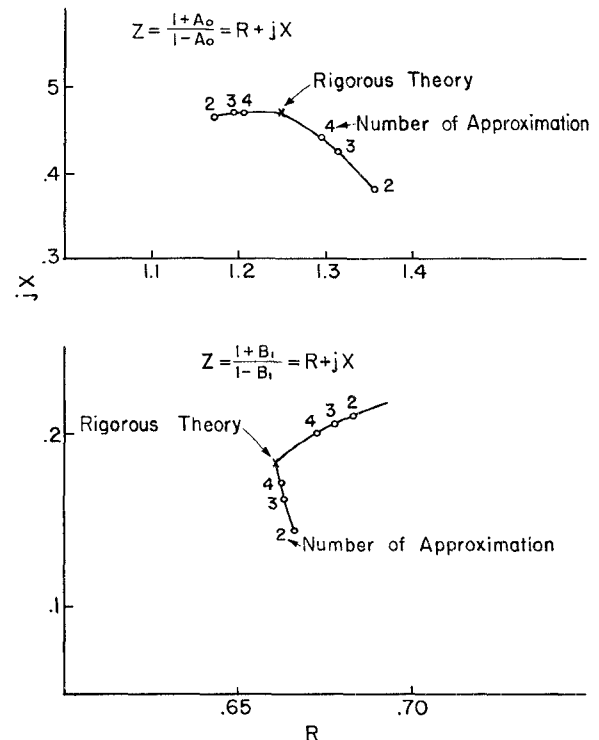

Fig. 8—Interface impedance plotted in complex plane.

The two methods for estimating the error will be illustrated for the above system at  $\xi = 1.0$  and  $\lambda_0 = 9.0$  cm. Under these conditions a rigorous result can be obtained from the Carlson-Heins theory<sup>3,8</sup> and an absolute check is possible.

### The Complex Plane

The input impedances  $Z_E$  and  $Z_H$  at the interface were calculated for the second, third, and fourth approximations. These are shown in Fig. 8 for free space and plate region incidence. Since the rigorous solution is

<sup>8</sup> J. F. Carlson and A. E. Heins, "The reflection of an electromagnetic plane wave by an infinite set of plates," *Quart. Appl. Math.*, vol. 4, pp. 313-329; January, 1947.



known in the present instance, it is apparent that smooth curves drawn through the two sets of points intersect at the correct value. It is also apparent that straight lines drawn through the third and fourth approximations intersect very near the correct value, and in fact calculation of the reflection coefficients from this point of intersection results in an error in magnitude of less than one per cent and a phase angle within two degrees.

*Reactances of the Equivalent Circuit*

Using the formulas listed in the appendix the following results were obtained

	no of approx	Electric Field	Magnetic Field
$X_{11}$	1)	3.260	$\infty$
	2)	3.558	5.281
	3)	3.708	4.937
	4)	3.793	4.652
$\frac{X_{11}X_{22} - X_{12}^2}{X_{22}}$	1)	0.0	0.058
	2)	0.0234	0.0429
	3)	0.0294	0.0424
	4)	0.032	0.0417
$X_{22}$	1)	4.021	$\infty$
	2)	4.208	6.410
	3)	4.317	5.469
	4)	4.390	5.182

As the electric field quantities are smaller and converge more rapidly than those for the magnetic field, the geometric mean of the two was taken to give

	$X_{11}$	$\frac{X_{11}X_{22} - X_{12}^2}{X_{22}}$	$X_{22}$
Geometric mean	4.20	0.0365	4.77
Carlson-Heins theory	4.05	0.0336	4.60

Using these values the final reflection coefficients are

	$A_0$	$B_1$
Variational method	0.226/49.94°	0.226/35.43°-180°
Carlson-Heins theory	0.229/50.2°	0.229/35.9°-180°

The magnitude in error is less than 2 per cent and in phase less than one degree, so that as far as accuracy is concerned there is little to choose between the two methods of estimating the accuracy. However, the complex impedance diagram is simpler to use and gives an excellent idea of the manner of convergence.

EXPERIMENTAL CONFIRMATION OF THE THICK PLATE THEORY

The equipment used has been fully described elsewhere.<sup>4,9</sup> It consists essentially of a strip transmission

<sup>9</sup> M. M. Z. El-Kharadly, "Investigation of certain types of artificial dielectrics," Ph.D. dissertation, Univ. of London, Eng.; 1952. Also *Proc. IEE*, vol. 102, pt. B, pp. 17-25; January, 1955.

line which attempts to simulate free space conditions with uniform plane wave excitation.

Because of its finite size the line has an inherent error which results in less than -3 per cent error in magnitude of reflection coefficient and less than five degrees in phase. The line has been calibrated using an array of very thin plates.<sup>4</sup>

The two-interface method with a short circuit termination was used.<sup>4</sup> (See Fig. 9.) Full details have been

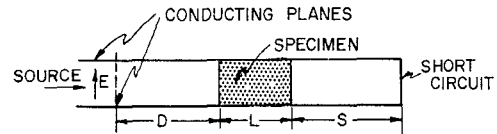

Fig. 9—Measurement of specimen in strip transmission line.

given elsewhere<sup>4</sup> but briefly the method consists of displacing the thick plate specimen (length  $L$ ) by known amounts ( $S$ ) from the short circuit and locating the corresponding positions ( $D$ ) of zero field strength. From the Weissfloch curve relating  $D$  and  $S$  the complex reflection coefficient of the slab follows and by obtaining this quantity for various lengths ( $L$ ), the properties of a single interface can be found.<sup>4</sup>

The specimen was constructed as in the previous work.<sup>4</sup> Waveguides were formed by wrapping 0.001 inch tin foil around machined dielectric blocks (expanded ebonite) and spacing these apart by thick plates, which consisted of machined bakelite covered with tin foil. The whole structure was wrapped in a single sheet of foil to make a rigid unit.

EXPERIMENTAL RESULTS

Figs. 10-13 show the results for two cases in which the plate thickness is small, but large enough to distinguish experimentally from the case of infinitely thin plates.

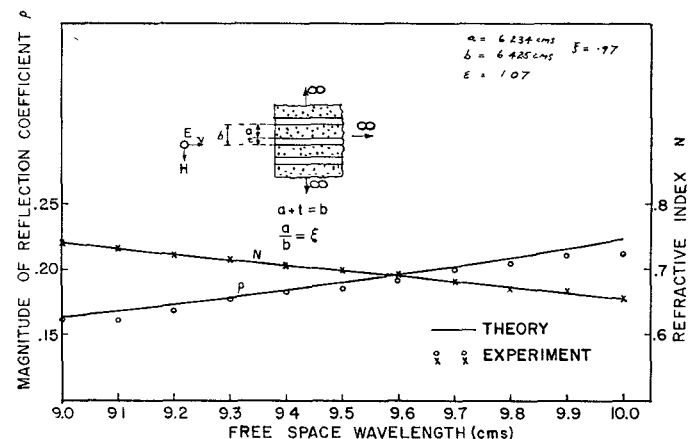

Fig. 10—Magnitude of reflection coefficient and refractive index for thick plates.<sup>1</sup>

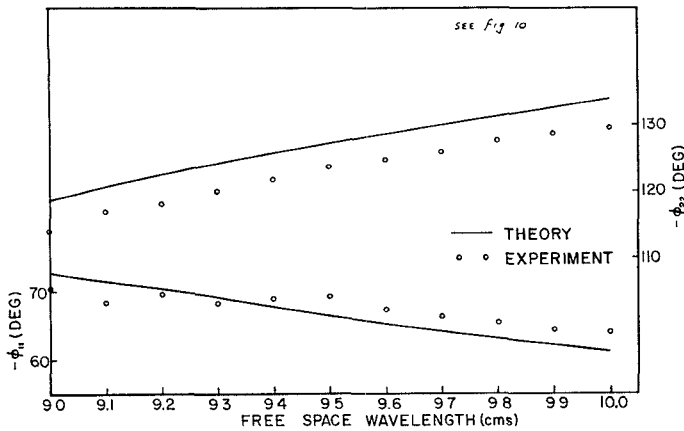

Fig. 11—Phase angles of reflection coefficient.

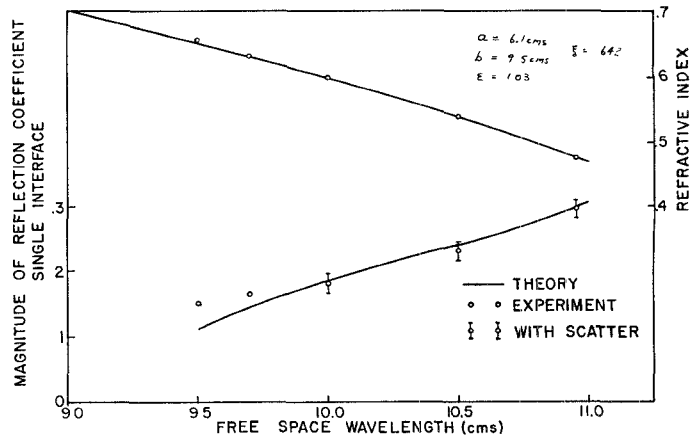

Fig. 14—Magnitude of reflection coefficient and refractive index for thick plates.<sup>3</sup>

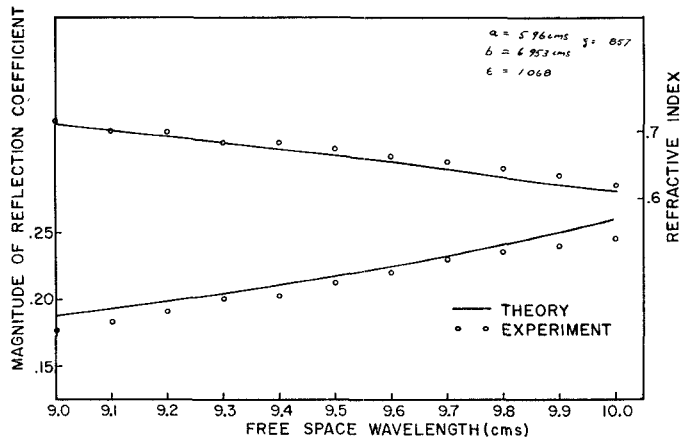

Fig. 12—Magnitude of reflection coefficient and refractive index for thick plates.<sup>2</sup>

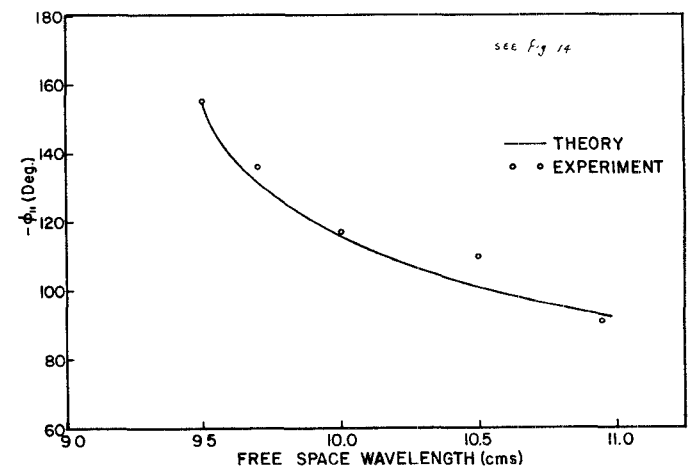

Fig. 15—Phase angle of reflection coefficient.

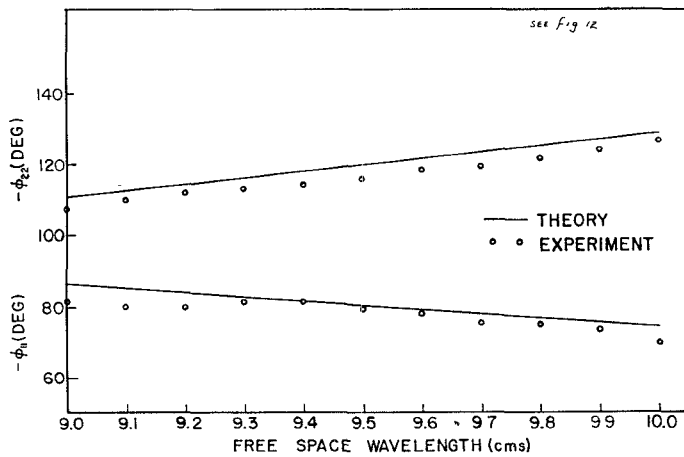

Fig. 13—Phase angles of reflection coefficient.

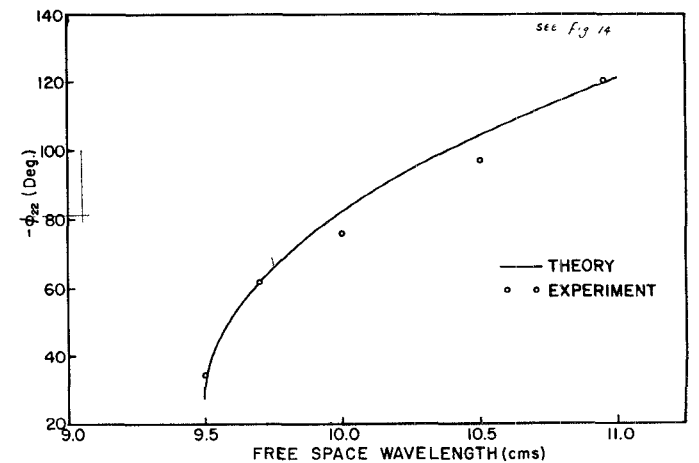

Fig. 16—Phase angle of reflection coefficient.

Figs. 14–16 show the results for a system in the region  $\lambda_0 > b$ . No measurements were possible for  $\lambda_0 < b$  as in this case the higher order waves caused considerable interference with the main beam. In fact, this interference was observed for  $\lambda_0$  larger than  $b$ , due to the finite size of the line. The field in the transmission line

approximated very closely to that of the  $H_{01}$  mode<sup>4</sup> and from this point of view the so-called normally incident plane wave can be considered to be the sum of two uniform plane waves slightly off normal. Although this

angle is only 5 degrees it is sufficient to account for the presence of higher order propagating waves at wavelengths noticeably longer than the theoretical  $\lambda_0 = b$ . In a typical case the higher waves were first noticed at  $\lambda_0 = 9.8$  cm compared to 9.5 cm at which point they caused considerable distortion.

The calculated curves in Figs. 7–13 were obtained from the variational expressions using the fourth approximation. An estimate of the error showed the magnitude of the reflection coefficient to be within 1 per cent and the phase within 2 degrees.

#### CONCLUSION

The experimental results given are typical of a large number taken from about ten specimens and the agreement between theory and experiment is of the same order throughout. Allowing for the inherent error of

the transmission line the worst error is  $-5$  per cent for the magnitude of reflection coefficient and within 5 degrees for the phase. Apart from the region of interference mentioned above, the thick plate theory appears to be quite satisfactory. Departures from this theory are believed to be due to the difference between the ideal and practical situations, mainly in regard to the imperfect means of plane wave excitation. Further study of the higher order propagating waves is required, although in general it is not desirable to have these higher orders present. It is worth noting that for a constant refractive index, the reflection at a single interface can actually be reduced by intentionally increasing the plate thickness, up to the point at which the first higher order wave starts to propagate.

The solution for arbitrary plane wave incidence offers no fundamental difficulty and is being extended.

## The Characteristic Impedance of Trough and Slab Lines\*

ROBIN M. CHISHOLM†

**Summary**—A variational method is used to develop an expression for the characteristic impedance of a “trough line” consisting of a circular cylinder mounted inside and parallel to the walls of a semi-infinite rectangular trough. The “slab line” consisting of a circular cylinder between infinite, parallel plates is treated as a special case of the trough line in which the bottom of the trough is taken to be infinitely remote from the circular cylinder. The solution has not been restricted to cylinders that are mounted exactly half way between the parallel walls of the trough; a simple formula is presented for calculating the tolerances which must be placed on the “centering” of the center conductor for a given allowable error in the characteristic impedance.

The expression for the characteristic impedance is presented as the sum of three terms. The first is a “zero order” logarithmic term, the second a “second order” correction term which vanishes as the center conductor becomes infinitely small, and the third is an “off-center” correction term which arises when the cylinder is not exactly half way between the parallel walls of the trough. The second order correction term amounts to about 0.3 ohms when the characteristic impedance is of the order of 50 ohms. A fourth order approximation using the same method changes this by about 0.001 ohm.

#### INTRODUCTION

**D**IFFICULTIES in manufacturing slotted lines for coaxial systems have led to the investigation of special types of coaxial lines for this purpose.

The present work is concerned with finding the characteristic impedance of two special types of two-conductor transmission lines which can be used for standing wave measurements. The “trough line,” illustrated in Fig. 1, consists of a circular cylinder mounted inside and parallel to the walls of a rectangular trough. The “slab line,” consisting of a circular cylinder between infinite, parallel planes, can be considered as a special case of the trough line in which the bottom of the trough is infinitely remote from the circular cylinder. The line is excited in the TEM mode by a generator connected between the circular cylinder and the walls of the trough and propagation is along the axis of the cylinder.

The practical difficulties involved in constructing coaxial slotted lines and the application of “slab lines” to the problem have been discussed in a paper by Wholey and Eldred.<sup>1</sup> These authors developed a solution for the “slab line” using conformal mapping to match the outer conductor everywhere and the inner conductor at four points which was accurate to about 0.1 ohm for characteristic impedances of the order of fifty ohms. Frankel<sup>2</sup> treated both the “trough line” and the “slab line” using conformal mapping for the case of an infinitely thin center conductor and, although a different method is

\* This work was supported in part by the Res. Council of Ontario, and by the Def. Res. Board of Canada, project number 5540-02.

† Dept. of Elect. Engrg., Univ. of Toronto, Toronto, Can.

<sup>1</sup> W. B. Wholey and W. N. Eldred, “A new type of slotted line section,” *Proc. IRE*, vol. 38, pp. 244–248; March, 1950.

<sup>2</sup> S. Frankel, “Characteristic impedance of parallel wires in rectangular troughs,” *Proc. IRE*, vol. 30, pp. 182–190; April, 1942.